

Data Sheet

SHF T850 B



Broadband Amplifier



Description

The SHF T850 B is a RoHS compliant ultra-broadband RF amplifier with a small footprint and a bandwidth of more than 100 GHz.

A distributed amplifier design is employed using our monolithic microwave integrated circuit (MMIC) inside special carriers to achieve the ultra-wide bandwidth.

This extreme bandwidth offers the capability to amplify binary signals of more than 100 GBaud while its good linearity enables this amplifier to drive modulators and lasers for PAM, optical QAM, OFDM and analog signals.

Ease of Use

Only a single 5 V supply is needed for operation.

Options

O4: Built-in bias tee on output (max. ± 5 V, max. 150 mA)¹

MP: Matches the phase of two amplifiers

QHS: Quad Heat Sink, four amplifiers on one heatsink

¹ If this option is chosen, the maximum gain and the maximum output power might be reduced by up to 1 dB. The output reflection might be increase by 1 dB. The DC resistance of a bias tee is about 6 Ω .



Specifications

Absolute Maximum Ratings

Parameter	Unit	Symbol	Min	Typ	Max	Comment
Maximum RF Input	dBm	$P_{in\ max}$			4	peak to peak voltage
	V				1	
DC Voltage at RF Input	V				±5	
DC Voltage at RF Output	V				±5	
Positive Supply Voltage	V		4.7		6.0	current depends on voltage typ. 0.4 A @ 5.0 V , allow 1 A
Case Temperature	°C	T_{case}	10	45	55	

Electrical Characteristics (At 45°C case temperature, unless otherwise specified)

Parameter	Unit	Symbol	Min	Typ	Max	Comment
High Frequency 3 dB Point	GHz	f_{High}	100			measured at $P_{in}=-20\ dBm$
Low Frequency 3 dB Point	kHz	f_{Low}			100	measured at $P_{in}=-20\ dBm$
Gain	dB	S_{21}	10			measured at $P_{in}=-20\ dBm$ @ 500 MHz
Input Reflection	dB	S_{11}			-12	< 50 GHz
					-10	< 80 GHz
					-7	< 100 GHz
Output Reflection	dB	S_{22}			-12	< 40 GHz
					-10	< 70 GHz
					-8	< 100 GHz
Maximum Output Eye Amplitude for Linear Operation	V			2		
Power Consumption	W			2		



Mechanical Characteristics

Parameter	Unit	Symbol	Min	Typ	Max	Conditions
Input Connector						1.0 mm female ²
Output Connector						1.0 mm male ²
Weight	g			35 80		without heatsink with single heatsink

² Other gender configurations are available on request.



Typical S-Parameters

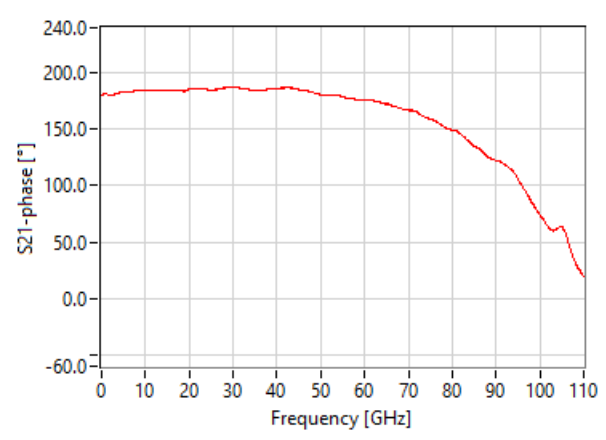
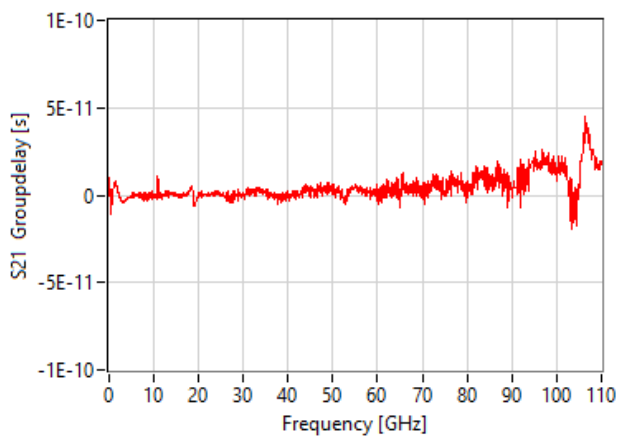
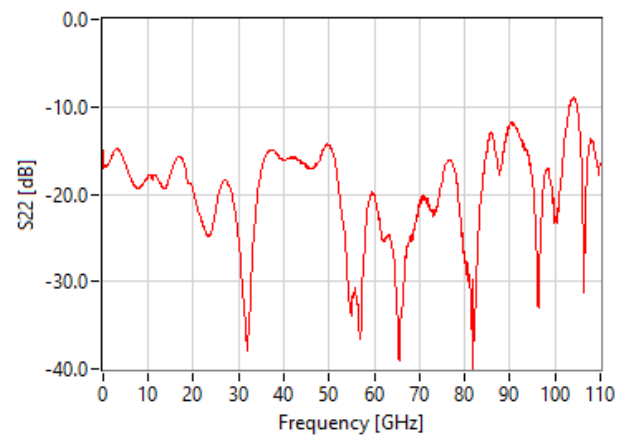
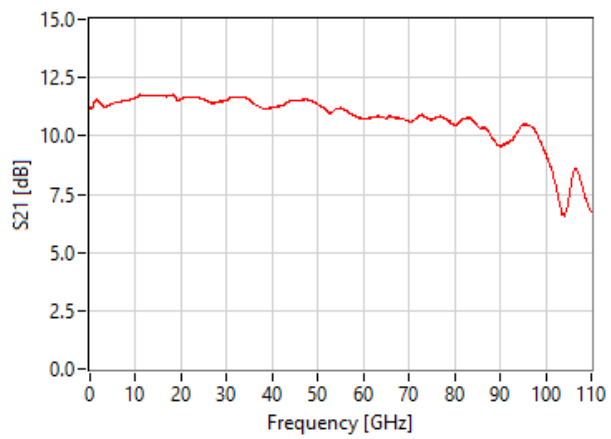
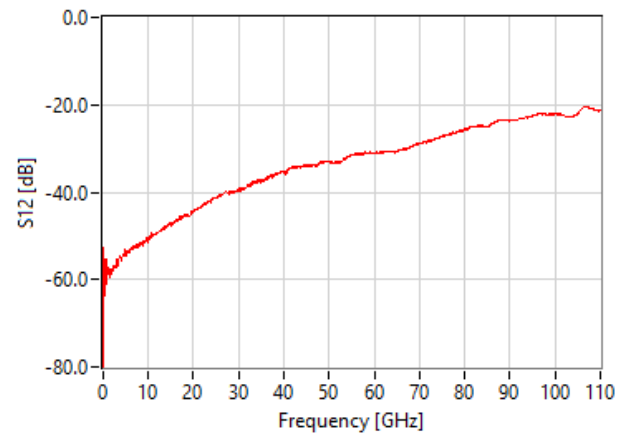
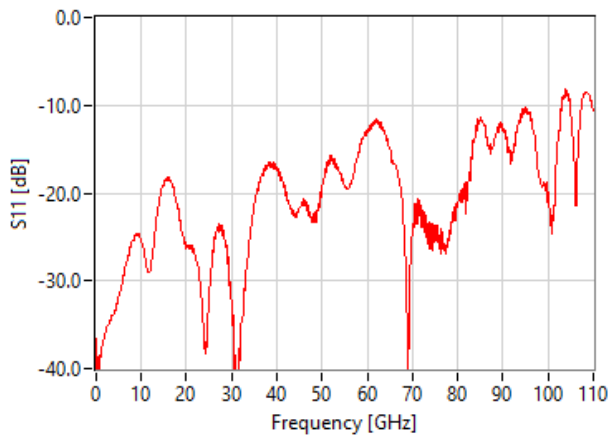

Aperture of group delay measurement: 160 MHz

Typical Waveforms

The measurements below had been performed using a SHF 12105 A Bit Pattern Generator, a PAM-MUX or a DAC and one of the scopes mentioned below. The outputs of the SHF module had been connected directly to the amplifier input. The output of the amplifier had been connected with a 20 dB attenuator (SHF ATT110 A) to the scope's input.

Please note that only the measurements taken with the Tektronix DCA DSA8300 will be part of the inspection report.

Measurements with:

- SHF 616 C PAM-MUX generating PAM4 signals (PRBS $2^{13}-1$)
- Keysight DCA N1000A, Precision Timebase & 122 GHz Sampling Module (N1046A)
- Linear FFE (7-Tap with 2 pre cursors) applied

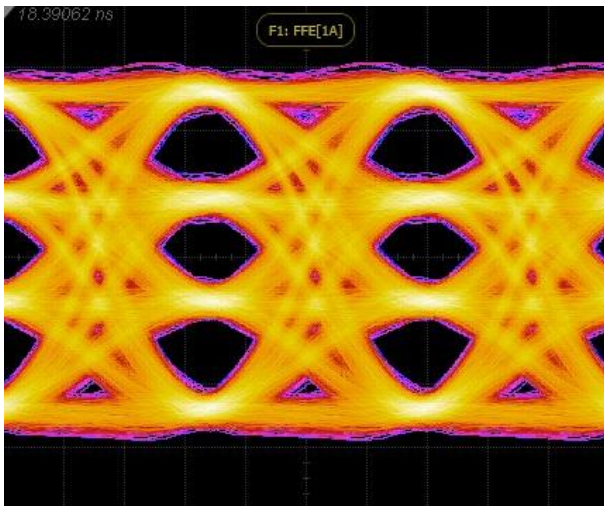

100 GBaud (200 Gbps) 470 mV Input Signal

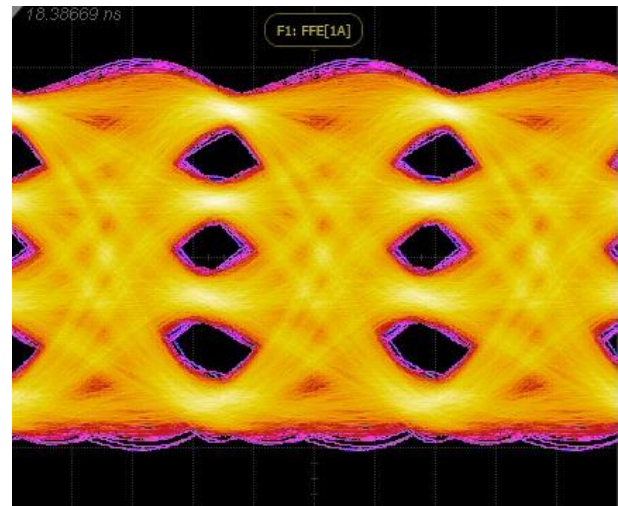

100 GBaud (200 Gbps) 1.65 V Output Signal

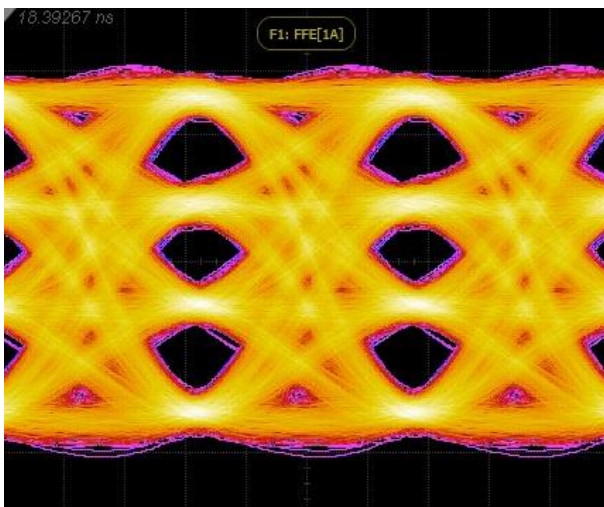

112 GBaud (200 Gbps) 470 mV Input Signal

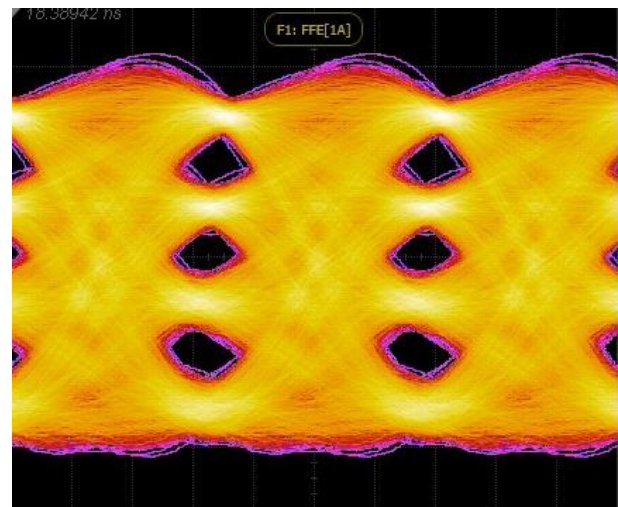

112 GBaud (200 Gbps) 1.65 V Output Signal



Measurements with:

- SHF 616 C PAM-MUX generating PAM4 signals (PRBS $2^{31}-1$)
- Tektronix DCA DSA8300 with Phase Reference 82A04B and Sampling Head 80E11
- No Filter applied

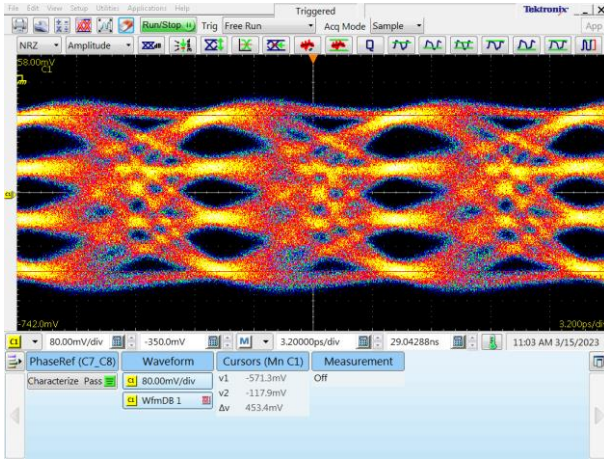

100 GBaud (200 Gbps) 450 mV Input Signal

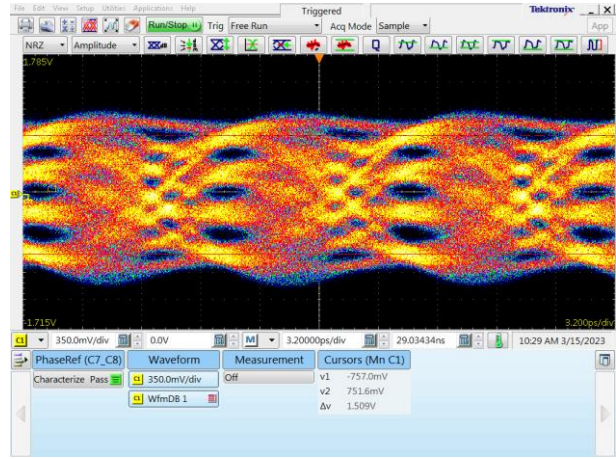

100 GBaud (200 Gbps) 1.5 V Output Signal

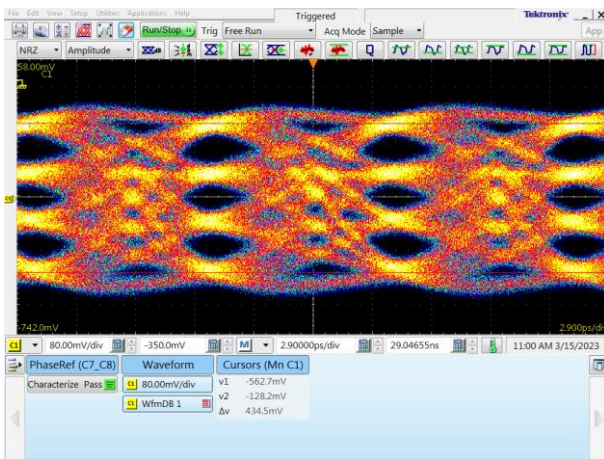

112 GBaud (224 Gbps) 430 mV Input Signal

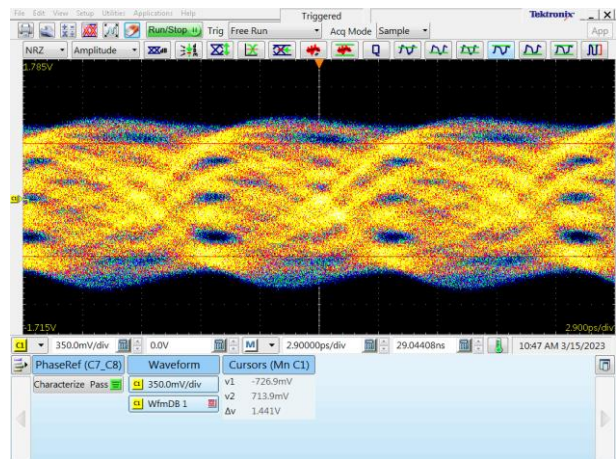

112 GBaud (224 Gbps) 1.44 V Output Signal



Measurements with:

- SHF 616 C PAM-MUX generating binary signals (PRBS $2^{13}-1$)
- Keysight DCA N1000A, Precision Timebase & 122 GHz Sampling Module (N1046A)
- Linear FFE (7-Tap with 2 pre cursors) applied

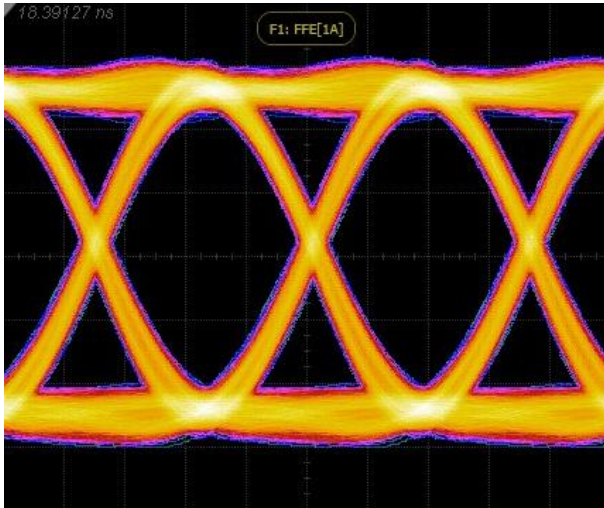

100 Gbps 450 mV Input Signal

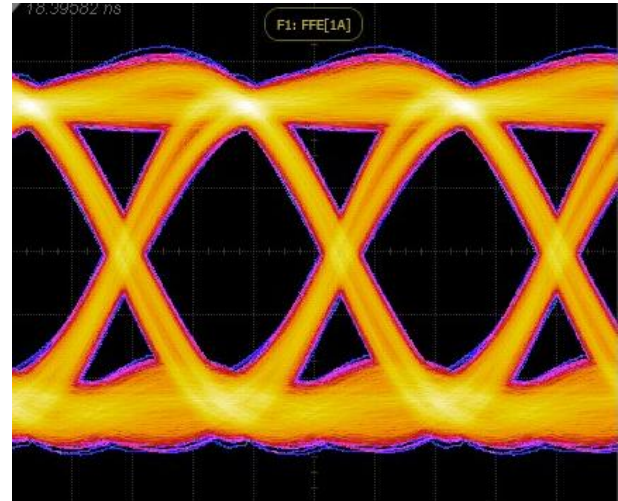

100 Gbps 1.6 V Output Signal

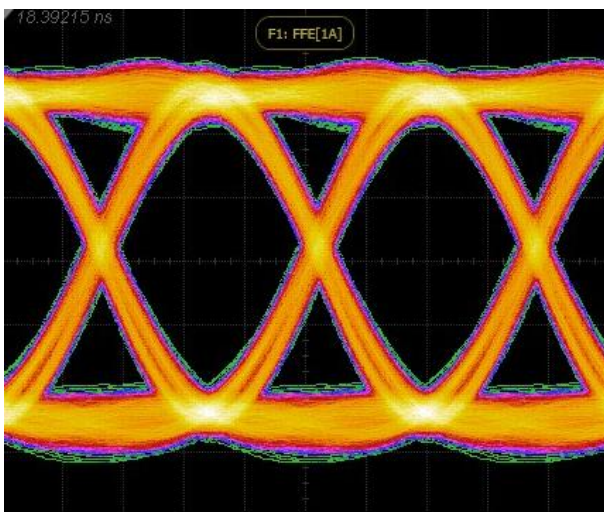

112 Gbps 430 mV Input Signal

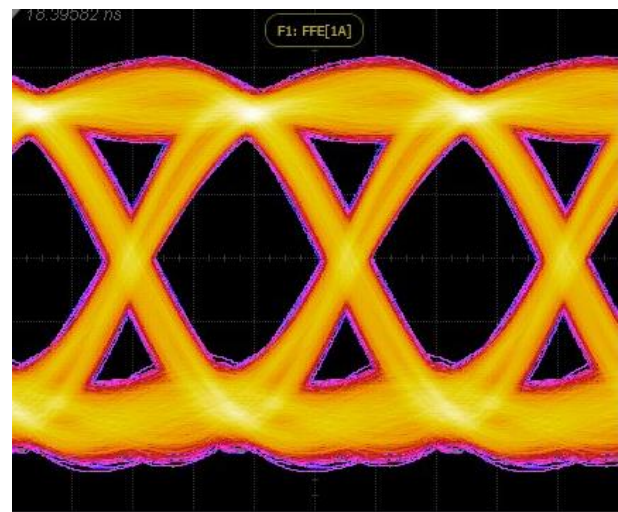

112 Gbps 1.5 V Output Signal



Measurements with:

- SHF 616 C PAM-MUX generating binary signals (PRBS $2^{31}-1$)
- Tektronix DCA DSA8300 with Phase Reference 82A04B and Sampling Head 80E11
- No Filter applied

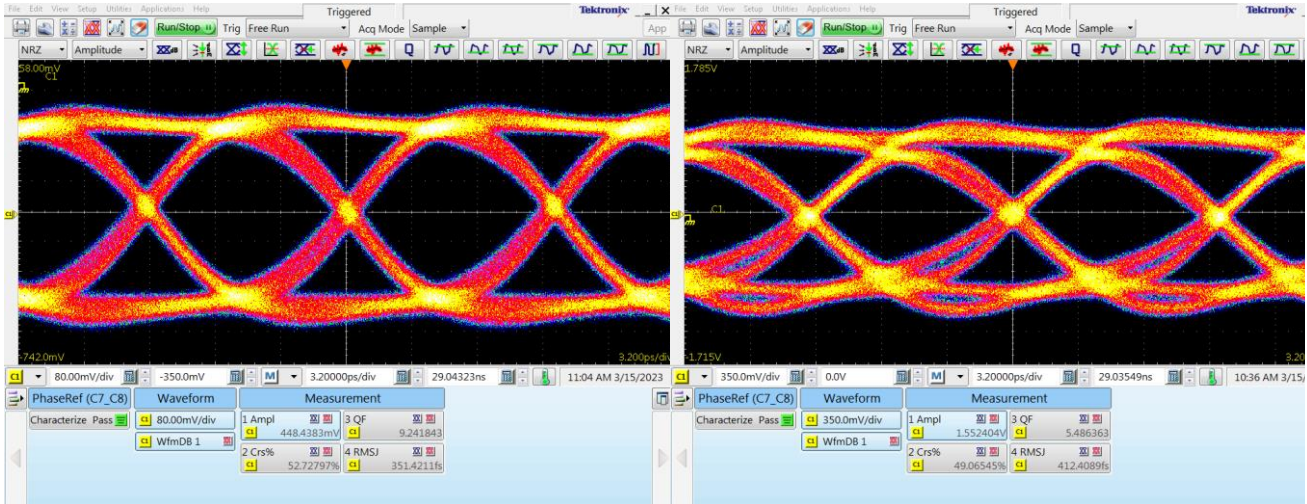

100 Gbps 450 mV Input Signal

100 Gbps 1.55 V Output Signal

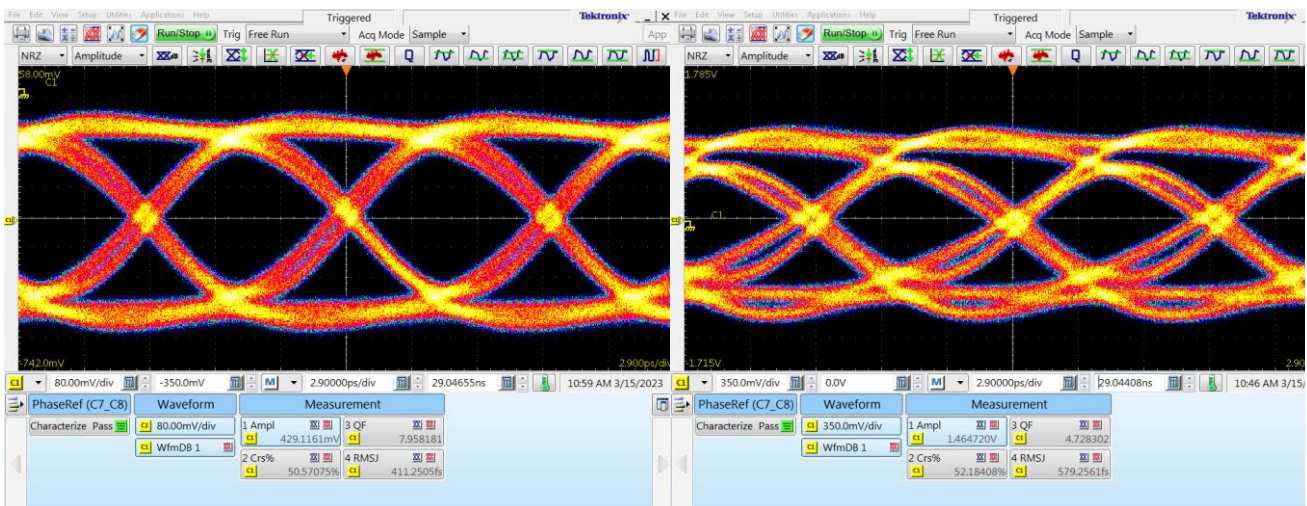

112 Gbps 430 mV Input Signal

112 Gbps 1.44 V Output Signal



Mechanical Drawing with Heat Sink

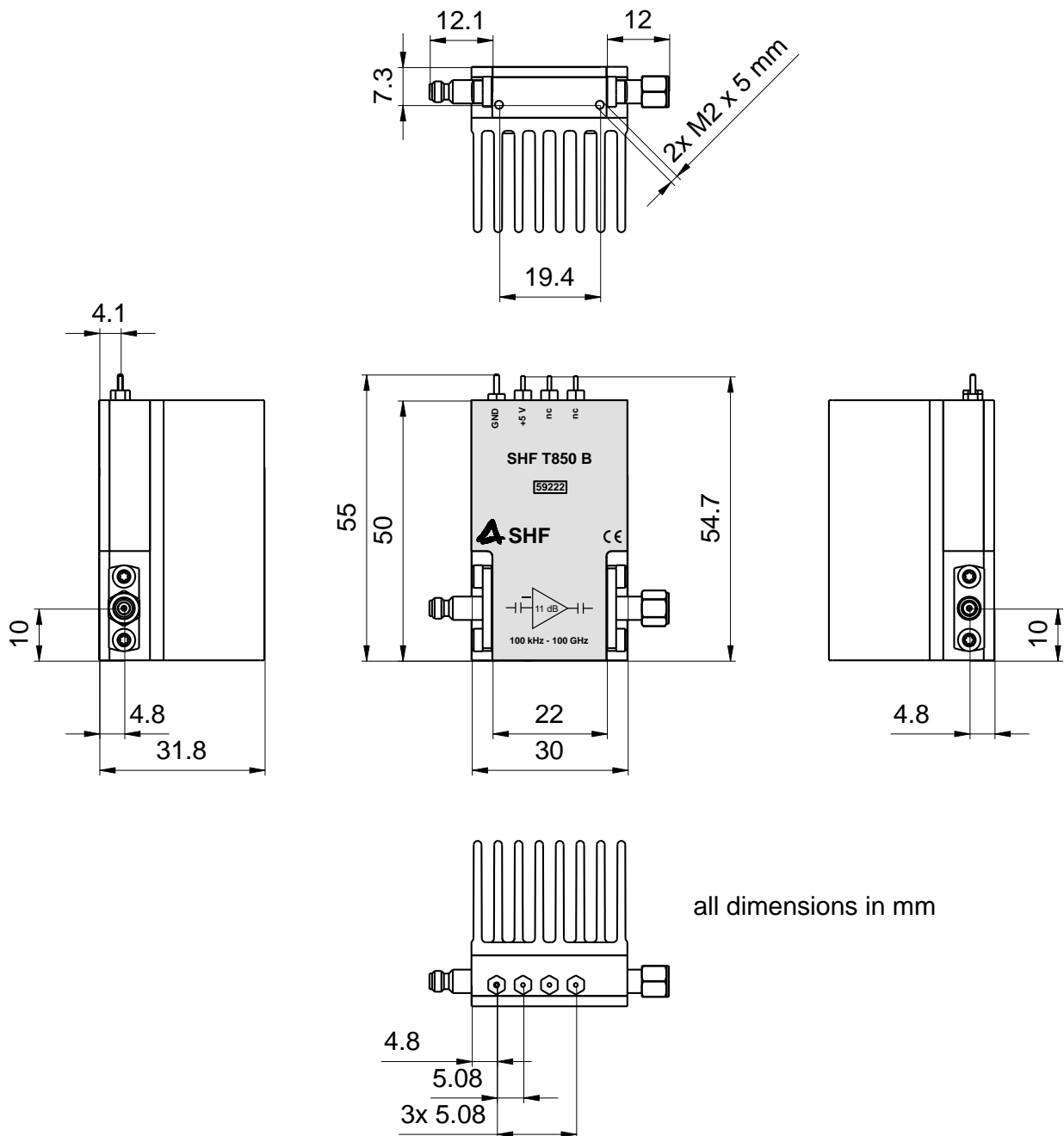

Pin assignment might change if a bias tee option is chosen.

For permanent mounting remove the heat sink from the amplifier. In that case, please ensure that adequate cooling of the amplifier is guaranteed. It is recommended to use thermal paste or a thermal gap pad for the mounting. In order to separate the heat sink from the amplifier, remove the four screws on the heat sink. Please note, thermal gap pad is used between the heat sink and the amplifier housing.



Mechanical Drawing without Heat Sink

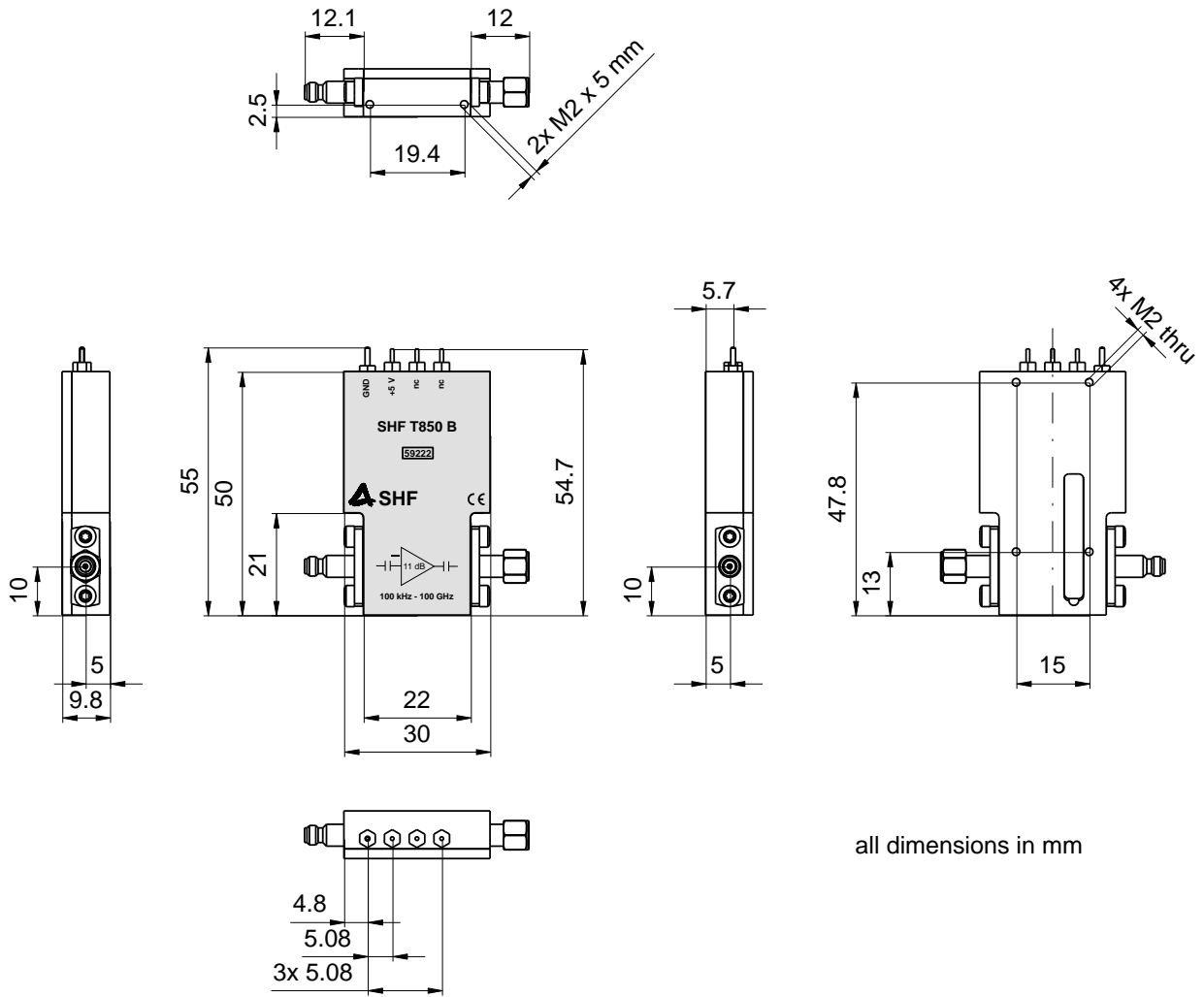

all dimensions in mm

Please ensure that adequate cooling of the amplifier is guaranteed.



User Instructions

Electrostatic sensitive device

1. To prevent damage through static charge build up, cables should be always discharged before connecting them to the amplifier!
2. First make the connections between amplifier, signal source and a 50 Ohm output load before supplying DC power to the amplifier!
3. The supply voltage can be taken from any regular 4.7...6 V, 1 A DC power supply and can be connected to the supply feed-through filter via an ON / OFF switch. Do not increase the supply voltage slowly from 0!
4. Using a 3 dB or 6 dB input attenuator will result in a 6 dB or 12 dB increase of the input return loss. For minimal degradation of amplifier rise time, these attenuators should have a bandwidth specification of greater 100 GHz (1.0 mm attenuators)!
5. While using a reflective load the output voltage has to be reduced to a safe operating level according to the magnitudes of the reflections.
6. ATTENTION: At radio frequencies a capacitive load can be transformed to an inductive one through transmission lines! With an output stage driven into saturation this may lead to the immediate destruction of the amplifier (within a few ps)!
7. The input voltage should never be greater than 1 Vpp equivalent to 4 dBm input power.
8. For the DC-connections flexible cable 0.2 ... 0.5 mm² / AWG 24 ... 20 are recommended. A maximum soldering temperature of 260 °C for 3 seconds is recommended for the feed-through. The ground pin requires significantly more heat as it is connected to the solid housing.



SHF Communication Technologies AG

Wilhelm-von-Siemens-Str. 23 D | 12277 Berlin | Germany

+49 30 772 051 0

sales@shf-communication.com

www.shf-communication.com